SELECTION GUIDE FOR
CONTROL VALVES
VERSION 2.0



The materials contained herein are provided "as is". Bray International makes no warranties, expressed or implied, and hereby disclaims and negates all other warranties, including without limitation, implied warranties or conditions of merchantability, fitness for a particular purpose, or non-infringement of intellectual property or other violation of rights. Further, Bray International does not warrant or make any representations concerning the accuracy, likely results, or reliability of the use of the materials contained in this document. In no event shall Bray International or its suppliers be liable for any damages (including, without limitation, damages for loss of data or profit, or due to business interruption,) arising out of the use or inability to use the materials in this document. Because some jurisdictions do not allow limitations on implied warranties, or limitations of liability for consequential or incidental damages, these limitations may not apply to you.

**“Selecting the right
control valve package ensures
optimized Process Control
for industrial automation”**



Table of Contents

Control valve basics.4

Selecting & Sizing Control Valves.....11

 Importance of Proper Valve Sizing..... 13

 Required Data for Sizing Control Valves 15

 Control Valve Sizing Software 17

 Actuator Sizing Software..... 18

 Control Valve Center of Excellence..... 19

Factors affecting Process Variability and control valve selection.....21

 Flashing, Cavitation & Erosion 22

 Noise & Vibration..... 26

 Deadband..... 27

 Pressure Recovery..... 27

 Temperature 29

 Actuator Friction Factor 30

 Piping Geometry Factory 31

Types of Control Valves.....32

Control Valve Positioners38

 Limit Switches 41

 Bray 6A Digital Pneumatic Positioner 42

 Bray 6P Pneumatic Positioner..... 42

 Bray Servo NXT..... 43

Control Valve Actuators44

 Scotch Yoke Actuators 44

 Rack & Pinion Actuators..... 46

 Electric Actuators..... 47

 Electro-Hydraulic Actuators..... 48

Fugitive Emissions.....49

Summary.....50

References.....52

Glossary.....53

Control valve basics.

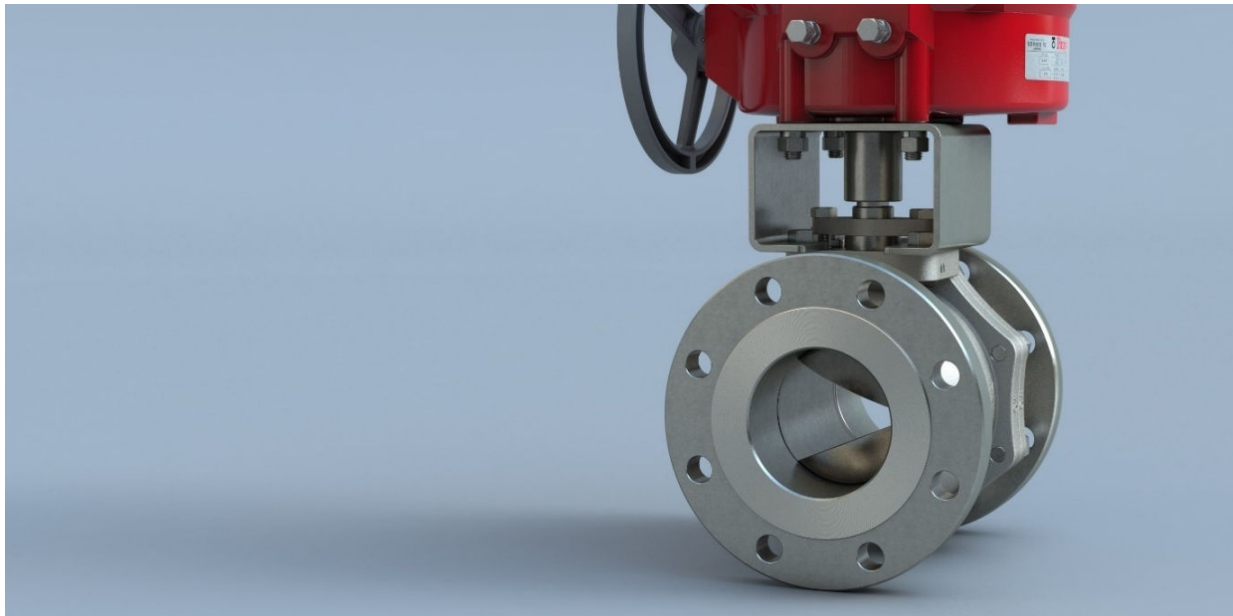

[ISA 75.05.01](#) defines a Control Valve as a power actuated device which consists of a Valve connected to an Actuator with Accessories and capable of modulating the position of the closure element according to a signal from the controller. Control valves are used to regulate the flow of fluids, such as gas, oil, water, and steam, by varying the geometry of the flow passage as directed by a signal from a controller. The variable geometry of the Control Valve enables the Control Valve to dynamically adjust the flow rate continuously based on feedback. Control valves are widely used to control or operate processes in a wide variety of applications including oil and gas, refineries, chemical and petrochemical plants, and power plants.

Control Valve Process Loop

A PID (Proportional-Integral-Derivative) loop is the feedback control mechanism widely utilized by the Control valve positioner. The PID controller continuously calculates an error value as the difference

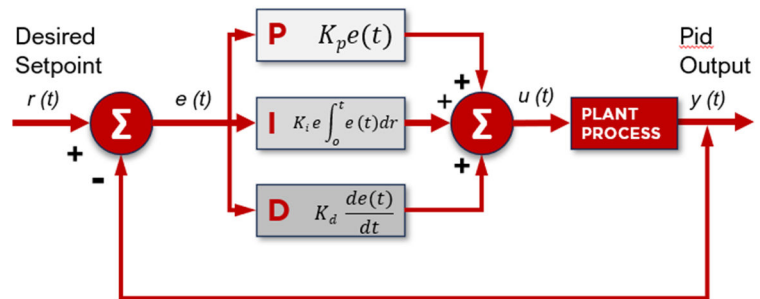

between a desired setpoint and a measured process variable, and applies a correction based on proportional, integral, and derivative terms. The proportional term is proportional to the current value of the error, the integral term accounts for past values of the error, and the derivative term is proportional to the rate of change of the error. The output of the PID controller is used to adjust the position of the control valve by sending a signal to the actuator. The PID loop can be adjusted which helps to improve the accuracy, repeatability, and stability of the control valve package by minimizing the error between the process variable and the setpoint.

The controller receives a command signal and compares it to the desired setpoint, and the actual position reported by the positioner. If there is a discrepancy, the controller instructs the actuator to change the valve position until the input signal and the valve position match. More complex systems can use inputs and variables from multiple sensors that monitor process conditions, such as temperature, pressure, flow rate, and other devices. The control loops and control valves in processing plants are essential for producing finished products, so the quality of the final product depends on the accuracy, repeatability, and reliability of the control valve package.

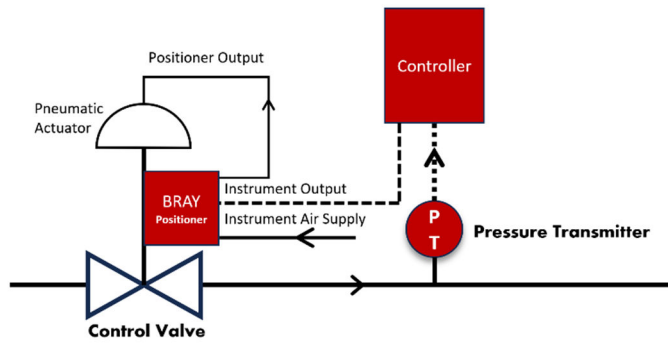

An example of a Control valve system for controlling and regulating pressure uses a controller, an actuator, a valve, and a pressure sensor to regulate the pressure in the system. The controller monitors the input signal from the pressure sensor which

provides real-time process conditions. The controller compares the pressure sensor data received to the desired setpoint set on the controller and the current valve position, which is reported by a positioner on the valve. The controller then sends a command signal to the actuator to adjust the valve position until the input signals and the setpoint match. A control loop can have different configurations, depending on the number and type of input signals and sensors. The control valve package affects the quality of the final product manufactured by the process which explains why the control valve package should have high accuracy, repeatability, and reliability.

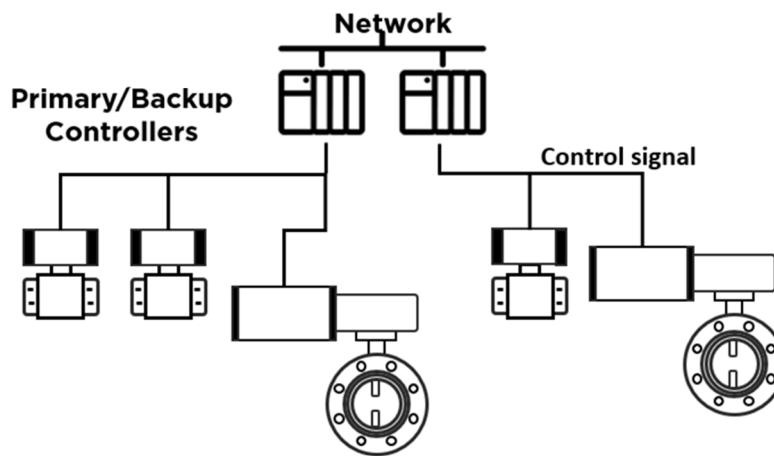

A representation of a DCS System

Historically, Programmable Logic Controllers, also known as PLC's, have been used for process control in process control loops.

As part of the higher level of industrial automation, the Distributed Control Systems (DCS) are gaining wider acceptance.



EtherNet/IP™

Bray's Series 70 Servo NXT Electric is the first DCS controllable actuator to provide Rockwell's Add-on Profile (AOP) for an EtherNet/IP capable actuator. This AOP enables customers to seamlessly register and quickly configure Bray S70 Actuators into Rockwell PLC's via the Studio5000 software. As a result, customers automatically see I/O data with meaningful and descriptive names.

This saves time and money during the design and commissioning phases by reducing complexity because guidance and online information in configuring the product is included in the AOP, improving the out-of-box experience. Another benefit is the device configuration data is stored in the Logix controller, enabling Automatic Device Configuration anytime the device is replaced.



Control Valve Flow Capacity

The flow capacity of a control valve is expressed by a Flow Coefficient (C_v). It is the maximum flow rate of a media that can pass through the valve. The Flow Coefficient is measured in Imperial units as C_v , which is the volume of water at 60°F (in US gallons) that flows through the valve per minute with a pressure drop of 1 psi across the valve. The metric equivalent of C_v is K_v , which is the flow rate of water at 16° C (in cubic meters per hour) that flows through the valve with a pressure drop of 1 bar.

Control Valve Flow Profiles

Control valves have different inherent characteristics that determine how the flow changes as the valve moves. Many control valves are not linear but are designed or engineered to suit the specific needs of each customer and process.

These “characterized” control valves produce various flow profiles. It is important that the flow profile matches the customer’s requirements to ensure process stability and control.

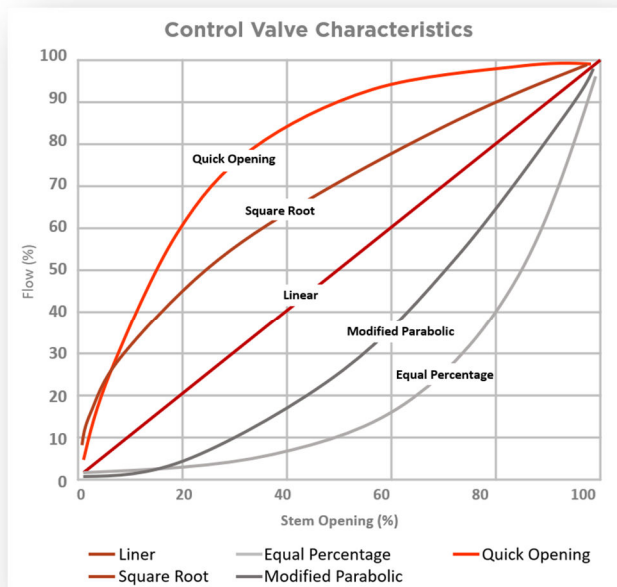

The chart above shows the flow through the valve versus the valve position. The curves are typical for most control valves. Note: The curves are based on constant pressure drop across the valve, which is called the inherent flow characteristic. When the actual flow in a system is plotted against the valve opening, the curve is called the installed flow characteristic.

The most common flow characteristics are:

- Linear - the flow capacity increases proportionally with the valve travel.
- Equal percentage - the flow capacity increases exponentially with the valve travel, such that equal increments of travel produce equal percentage changes in the Cv.
- Modified parabolic - provides fine throttling at low flow capacity and approximately linear characteristics at high flow capacity.
- Quick opening - provides large changes in flow for small changes in position, caused by high gain in the profile and controls.
- Square Root - provides quick opening capability at low opening or travel and linear characteristics at high flow capacity

Types of Control Valves

Control valves can be classified into two basic types: linear and rotary. Linear control valves use a sliding stem that moves a piston-like element to open and close an orifice and regulate the flow rate through the valve. Rotary control valves use a rotating stem that turns a disk-like element to open and close an orifice and regulate the flow rate through the valve.

Some examples of linear and rotary control valves are:

Linear control valves: globe valves, gate valves, diaphragm valves, pinch valves, needle valves, etc. These valves have a linear motion of the stem and the closure element, which can be a plug, a disk, a diaphragm, or a pinch. These valves can provide precise and accurate flow control, but they may require more force and space to operate.

Rotary control valves: ball valves, butterfly valves, plug valves, etc. These valves have a rotary motion of the stem and the closure element, which can be a ball, a butterfly, a plug, or a disk. These valves can provide fast and easy operation.

Selecting & Sizing Control Valves

Selecting the appropriate control valve is essential to achieve optimal process control performance. Beyond simply identifying the correct valve type that aligns with the flow characteristics of the process, it's crucial to recognize control valves as comprehensive systems. These systems encompass not only the valve itself but also the actuator, valve controller, and sensors that provide process condition feedback.

To achieve accurate sizing, follow these general steps:

1. Collect Process Control Parameters including details about the control precision, repeatability, rangeability, actuation speed requirements for response to conditions (which affects actuation choice). precision of control, dynamic response to fluctuations in process conditions, potential for upset conditions and noise attenuation requirements.
2. Obtain process condition specifications including the media type, viscosity, the presence of suspended solids (such as abrasive media), temperature of the process, pressure, flow velocity, pressure drop across the orifice, and the risk of erosion from cavitation, flashing, and solids.
3. Include additional information such as pipe size, pressure class, valve and or pipeline, requirements for materials of construction, trim, and coatings.
4. Be sure to include factors such as delivery time, maintenance intervals, longevity requirements of the valve, economic restrictions, plant outage schedules, and maintenance plans that could affect the life of the valve.

Process control precision and rangeability are two of the most important factors that determine the type of valve and actuation package required. Therefore, fine control and coarse control applications may need different solutions. However, the

controller, positioner, and actuator can also influence the accuracy, repeatability, and precision of the control valve package you select for your application.

Rangeability is a term that characterizes the ability of a control valve to effectively manage a broad spectrum of flow rates while maintaining

$$\text{Rangeability} = \frac{\text{Maximum flow}}{\text{Minimum flow}}$$

optimal control. Rangeability is expressed mathematically as a ratio, representing the maximum controllable flow rate in relation to the minimum controllable flow rate. A valve exhibiting superior rangeability is proficient in adapting to fluctuating process conditions, enabling it to efficiently manage both high and low flow rates. Effectively, rangeability is delineated as the ratio of the maximum to the minimum flow rates that a control valve can handle. Valves with high rangeability ratios generally provide coarse control, while valves with low rangeability provide fine control. This implies that there is a balance between precision and range to consider during the control valve selection process. Moreover, the precision of control valves is also impacted by the actuator and controller that the control valve is paired with.

Precision refers to the ability of a control valve to consistently achieve the desired flow rate or position accurately. In other words, it measures how closely the valve can maintain its intended performance under varying conditions. A precise control valve ensures minimal deviation from the setpoint, contributing to stable process control.

Repeatability pertains to the valve's ability to reproduce the same output (e.g., flow rate or position) when subjected to identical input conditions. It assesses the consistency of valve performance during repeated cycles. A highly repeatable control valve reliably delivers consistent results, enhancing process stability.

Another important consideration for process flow control applications is upsets. Upsets are disturbances in the process caused by various factors. An upset is a condition where the process deviates from the intended operating conditions. Upsets can be caused by pressure, temperature, blockages, obstructions, failed upstream or downstream conditions, backflow, or other factors. Control valve systems that face potential upset conditions require special attention to ensure process control. Upset conditions can affect product quality, yield, or even cause costly downtime.

Importance of Proper Valve Sizing

Properly sizing the control valve is crucial for process control and variability. Choosing a control valve with a rangeability that exceeds the required flow can cause several problems. An oversized control valve will reduce the control precision, because the desired flow range becomes a smaller fraction of the valve's overall control range.

Let's look at an example. If the required flow range of a control valve application is 6gpm to 11gpm and a control valve is selected that has a range of 0 to 30gpm, then the desired flow range is 3X the required flow rate. This means that the range of travel used for the process is only 29° of valve travel. The range of flow utilized will occur between 30° and 59° of valve opening. The rest of the travel from 60° to 90° is beyond the flow needs and useless for precision.

It would be much better to install a valve with a range of 0 to 12gpm. In this case, the desired flow range will occur between 30° and 84° of valve opening, which is 54° of valve travel. This difference is called the gain. The gain of the control valve is the ratio of the change in flow to the change in input. In the control valve, the output is the flow in the system and the input is the valve position.

For a control valve, deadband refers to a range of controller signal that fails to trigger any activity of the valve. Deadband can occur when the valve needs to change direction. To compensate for deadband, the controller must send additional output, which can cause the valve to overshoot its target position. When a larger than needed valve is used, the likelihood of overshooting increases due to the loss in control fidelity.

All control valves face flow induced pressure gradients that affect control precision. When a rotary control valve is closer to fully closed, there is more force exerted on the seat by the ball due to the upstream pressure. This causes more friction between the ball and the seat than when the valve is more open due to the pressure differential. This requires more force to overcome the static friction before the valve moves. Higher static friction translates to more time for the force to build up before the valve overcomes the static friction and moves, increasing the dwell time or deadband. Operating near the closed position on an improperly sized

control valve will also affect the precision, which will result in more process variability. As the control valve starts to move, overcoming the static friction, it may jump, causing an overshoot. This phenomenon also makes the control valve act more like a quick opening valve, when the initial friction is overcome the valve moves faster than it will over time.

Required Data for Sizing Control Valves

Data	Description
Control valve function	The purpose of the control valve in the process, such as daily start up, continuous or batch control, duration at min flow, etc.
Process data	The data for the normal, maximum, and minimum flow conditions, such as fluid name and properties, pressure inlet and outlet, temperature, etc.
Performance requirement	The process conditions that define the desired performance of the control valve, such as rangeability, accuracy, repeatability, responsiveness, etc.
Service life expectation	The expected lifespan of the control valve under severe duty conditions, such as erosion, corrosion, cavitation, flashing, noise, etc.
Air supply or voltage	The available air supply or voltage for the actuation and accessories of the control valve, such as pneumatic, hydraulic, or electric actuators, positioners, solenoids, limit switches, etc.
Fluid name and properties	The name and properties of the fluid that flows through the control valve, such as density, viscosity, vapor pressure, specific heat, etc.
Line size	The size of the upstream and downstream pipes that connect to the control valve, such as diameter, length, etc.
Pipe schedule	The schedule of the upstream and downstream pipes that connect to the control valve, which indicates the wall thickness and pressure rating of the pipes.
Temperature	The minimum, normal, and maximum temperature of the fluid that flows through the control valve.
Upstream pressure	The minimum, normal, and maximum pressure of the fluid before it enters the control valve.
Downstream pressure	The minimum, normal, and maximum pressure of the fluid after it exits the control valve.

End connections	The type of end connections that attach the control valve to the upstream and downstream pipes, such as flanged, threaded, welded, etc.
Pressure class	The pressure class of the control valve, which indicates the maximum allowable pressure that the valve can withstand at a given temperature.
Leakage rate	The maximum allowable leakage rate of the control valve, which indicates the amount of fluid that can pass through the valve when it is fully closed.
Preferred valve style	The preferred style of the control valve, such as globe, ball, butterfly, segment, etc.
Material requirements	The material requirements of the control valve, such as the body, trim, seat, stem, packing, etc.
Fail position	The desired failure position of the control valve, which indicates the position of the valve when the actuator fails or loses power, such as fail open, fail closed, fail last, etc.
Available air supply	The available air supply for the actuator and accessories of the control valve, such as pressure, flow rate, quality, etc.
Max shutoff pressure	The maximum pressure that the control valve can shut off against, which depends on the actuator size and type, the valve style and size, the seat material and design, etc.
Sound level requirements	The sound level requirements of the control valve, which indicate the maximum allowable noise that the valve can generate due to fluid flow, turbulence, cavitation, etc.
Control signal	The control signal that the controller sends to the positioner or the actuator of the control valve, such as 4-20mA, 0-10V, HART, Profibus, etc.
Accessories	The accessories that are attached to the control valve, such as positioners, solenoids, limit switches, transmitters, gauges, filters, regulators, etc.
Media	The type of fluid to be controlled, temperature of the fluid, viscosity of the fluid, concentration, impurities, specific gravity, total media chemistry, etc.

Control Valve Sizing Software

Bray offers sizing software for valves that is available to download from our website. The Bray Sizing Program is a powerful tool that can help you produce an ISA specification sheet faster and help predict noise and cavitation. To use the software, please follow these steps:

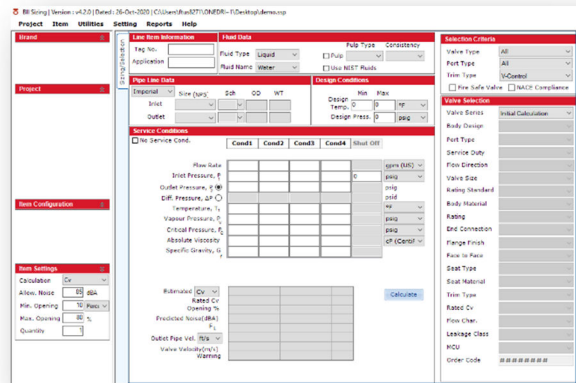

1. Download the EXE file from this link and run it (15 MB). [DOWNLOAD LINK](#)
2. The setup files will be extracted automatically for you.
3. Follow the on-screen installation steps.
4. Launch the Bray Sizing Program.
5. Press F1 in the program to access the Help Manual.

If you are an existing user and want to update the software, please follow these steps:

1. Download the EXE file from this link. Do not run it from the server (15 MB).
2. Launch the Bray Sizing Program.
3. Run the setup once. This will remove the previous version.
4. Run the setup a second time. This will install the new version.

Actuator Sizing Software

Bray also offers actuator sizing software that you can use right on our website. The Bray Act Size Program is a powerful tool that can help you produce an ISA specification sheet faster. To use the software, please follow these steps:

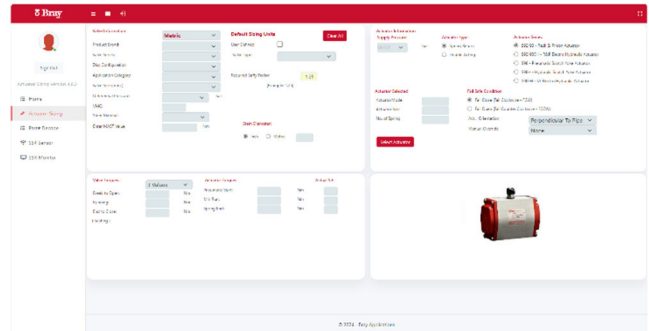

1. Visit our website to run the Act Sizing Software here. [LINK HERE](#)
2. The software is a web native application with nothing to download.
3. Follow the on-screen instructions and steps.
4. Current version: ActSize V4.8.2.

For any assistance/Issues related to sizing program, please write to: [Bray Sizing Software Support](#)

Control Valve Center of Excellence

Selecting the correct control valve is essential for maintaining process stability in your process control loop. Actuation and controls are also very important for the overall process stability. That is why Bray has created the Control Valve Center of Excellence, where we design, engineer, and test our control valve packages extensively to provide process control solutions that deliver consistent results in any process conditions.



Our engineering team has decades of experience in control valve applications and access to state-of-the-art testing labs that allows us to test our control valve packages in real-world environments by measuring the flow rate versus the valve opening in a physical test setup. This ensures that our solutions meet our customers' expectations and provide reliable, trouble-free, and high-performance operation.

Simulation

Simulation is one of the advanced tools that the Bray team uses to test and validate control valve solutions for our customers. Simulation allows the Bray engineering team to verify that our mathematical predictions match the simulation results for the process control.

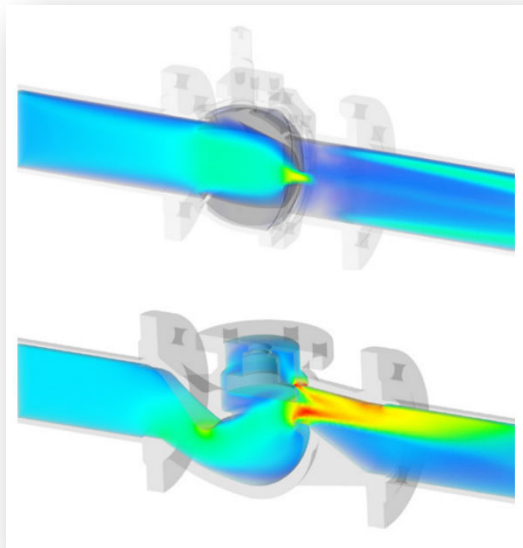

Advanced simulation enables our team to estimate the flow performance characteristics, such as noise, cavitation, and other parameters. The simulation results are compared to the mathematical predictions made by our engineering team. Computational Fluid Dynamics (CFD) is an effective method to evaluate the performance curve during the design stage for the control valve. Every valve design undergoes design validation to meet the required performance.

Certified & Trusted

“Bray is committed to customer support and providing personal attention to every customer. For thirty years, Bray has continued to improve and broaden its line of products and earning the trust of our customers. Today, Bray control valve solutions are trusted worldwide by thousands of companies. We look forward to helping solve your control valve challenges too.”

Factors affecting Process Variability and control valve selection.

Process variability significantly influences various aspects of plant performance, including yield, productivity, and overall profitability. In the pursuit of consistently delivering high-quality products, industrial plants must prioritize process stability, especially in today's competitive business environment.

While plants often invest heavily in sensors and monitoring electronics to control and monitor the process, the control valve package itself directly impacts the process yield and profitability the most.

Challenges arise when the control valve chosen is inadequately matched to the specific process conditions they encounter. This mismatch can occur due to incomplete understanding of process dynamics or insufficiently defined factors within the control loop. Consequently, the process may exhibit more variability than desired, affecting overall efficiency and product quality.

Moreover, the same factors influencing process performance can also adversely impact the reliability of the control valve itself, driven by selection of control valves that are not well-suited to the dynamic process conditions they operate in, resulting in shortened valve life, more downtime and reduced productivity. Therefore, an approach to control valve selection should include a comprehensive understanding of process dynamics that ensures process stability, achieving optimal plant performance.

There are several dynamic process control concepts to consider in control valve applications that must be considered beyond pressure, temperature, and flow rate including Flashing, Cavitation, Erosion, Noise and Vibration.

Flashing, Cavitation & Erosion

A variable flow restriction in the flow path is the basis of how all control valves operate. The restriction reduces the flow by changing the velocity through the restriction, which also causes a drop in pressure. The point of maximum contraction is called the Vena Contracta. According to Bernoulli's principle, the speed of a fluid increases as its static pressure or potential energy decreases. This principle was published by Daniel Bernoulli in his book Hydrodynamica in 1738.

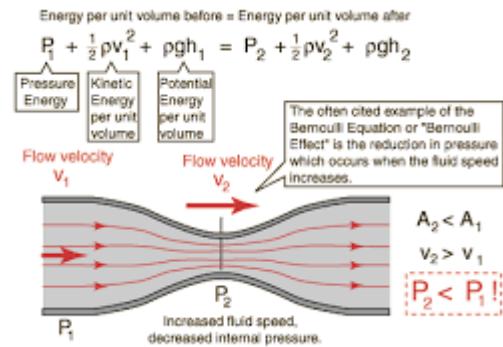

Cavitation is a phenomenon that occurs when the liquid's pressure drops below its vapor pressure within the valve, creating small vapor-filled cavities in the liquid. These cavities, or bubbles, collapse under higher pressure and create shock waves that can damage the control valve.



Cavitation Damage

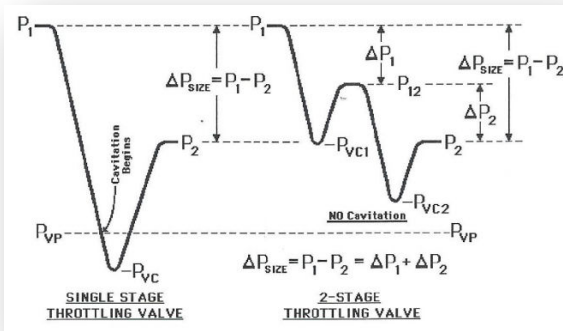

To solve the cavitation problem, there are several approaches that can be used. One method is to use a multi-stage pressure letdown solution, which reduces the pressure gradually and avoids velocity spikes that can cause cavitation.

Another method is to use a tortuous path pressure letdown, which is like the multi-stage solution but within a single valve assembly. This method reduces the pressure drastically by making the flow turn 90 degrees multiple times, which removes kinetic energy from the flow.

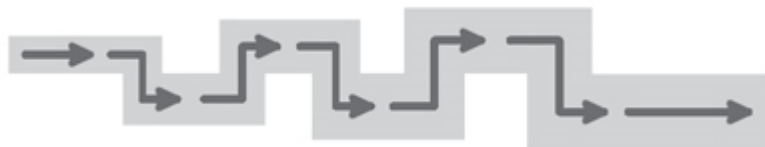
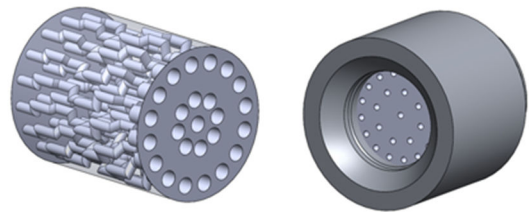

Multiple Right Angle Expanding flow path to radically reduce kinetic energy

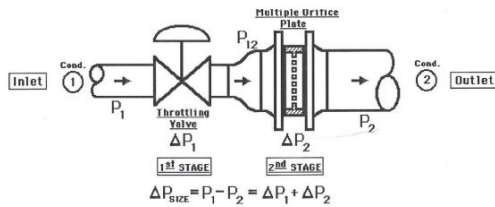
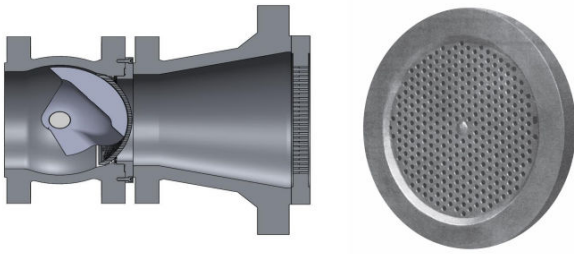

Other methods to prevent cavitation include choke plates and diverging nozzles, which increase the pressure and decrease the velocity. The diffuser plate downstream from the control valve is another example of this method, which splits the pressure drop between the valve and the plate and eliminates cavitation. These are some of the methods that can be adapted to different flow control conditions.

Flashing is another phenomenon that can occur in control valves. Flashing happens when the pressure falls below the vapor point of the fluid, causing the fluid to turn into a gas. The gas expands and flows faster than the fluid through the same opening. For example, propane has an expansion rate of 270:1. If flashing occurs when throttling propane, the gas exiting the valve will try to fill 270 times the volume of the liquid propane. Flashing is not as noisy as cavitation, because the gas cushions the liquid, but it can cause similar damage. The main difference between flashing and cavitation is that the pressure downstream remains below the vapor point in flashing.



Flashing damage

Erosion of the valve can also result from mechanical impingement of suspended solids in the flow media. One example is frac sand in fluid from a well. The sand particles hit the surfaces of the control valve and create a sand-blasting-like effect on the valve components in the flow path. The impingement angle affects the amount of erosion that occurs.



Erosion due to high velocity flow

Flashing, cavitation, and erosion can all impair the throttling and shut-off capability of the control valve over time. Severe flashing and cavitation can shorten the service life of the control valve and affect the process control. Damage to the control valve from these phenomena can lead to costly downtime and productivity loss.

Noise & Vibration



Acoustic disturbances emanating from control valves in industrial facilities can have various sources from aerodynamic noise to cavitation to flow-induced vibration or even harmonic vibrations. Regardless of source, noise poses a significant risk, potentially impairing the auditory

health of employees. The Occupational Safety and Health Administration (OSHA) enforces stringent regulations to limit noise exposure in occupational settings. OSHA stipulates a Permissible Exposure Limit (PEL) for noise, which is defined as an 8-hour Time Weighted Average (TWA) noise level of 90 dBA. For noise levels reaching 100dBA, OSHA's recommended exposure duration limit is 2 hours. Furthermore, OSHA mandates that the duration of exposure should be halved for each increment of 5dBA. For example, the exposure limit at 95 dBA is four hours. This policy underscores OSHA's commitment to safeguarding the auditory health of workers in industrial environments.

Deadband

Deadband is a phenomenon that compromises the precision of process control. It represents a range within the control spectrum where no discernible alterations in the process are observed. As an example, let's consider a Rotary Control Ball Valve with a total rotation of 90°. In this valve, the first 20° of rotation might not result in any noticeable change in the flow rate of the fluid. This means that even if the valve is opened from 0° to 20°, the process remains unaffected. This range (0° to 20°), in the given example would be referred to as the "deadband" of the control valve. So, despite the movement of the valve, the process does not respond, hence the term 'dead' band. This deadband can affect the precision of process control, as the valve must exceed this initial 20° rotation before any significant process change occurs. This example illustrates the concept of deadband in the context of a Rotary Control Ball Valve. It's important to note that the exact degrees can vary based on the specific design and calibration of the valve.

Pressure Recovery

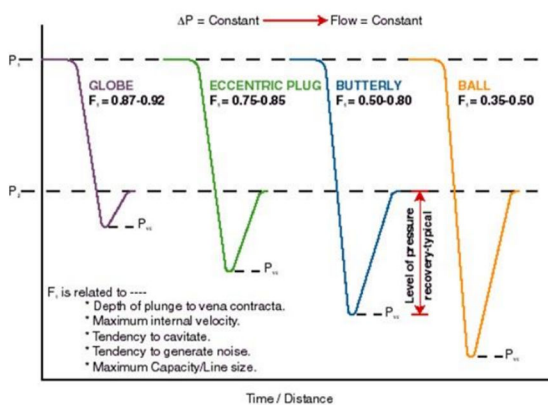

Pressure Recovery refers to the process where the fluid velocity decelerates, and the pressure increases or recovers after passing through the valve orifice, often characterized by the inlet's total pressure recovery, which measures the amount of the free stream flow conditions that are "recovered". The pressure recovery factor is a measure of how much the pressure recovers after passing through a

valve. It depends on the valve opening (vena contracta) and the upstream pressure. The pressure recovery factor determines the critical flow conditions, for example, where the flow becomes choked, and the pressure drops below the vapor point.

A higher Pressure-Recovery-Factor can be beneficial in situations where cavitation or flashing is a concern.

Cavitation and flashing are phenomena that occur when the pressure in a fluid drops below its vapor pressure, causing the fluid to vaporize. This can lead to damage to the valve and other components in the system due to the violent collapse of vapor bubbles when the pressure recovers downstream of the valve.

A control valve with a higher Pressure-Recovery-Factor will recover less in the downstream. has a greater ability to recover pressure downstream. This means that the pressure downstream of the valve is less likely to drop below the vapor pressure of the fluid, reducing the risk of cavitation or flashing. Note: F1 varies from 0 to 1. High Pressure recovery factor F1 means lower pressure recovery, and less cavitation tendency.

Therefore, in applications where cavitation or flashing could be problematic, a control valve with a higher Pressure-Recovery-Factor would be beneficial. This might include systems with high-pressure differentials, meaning a lower downstream pressure, or where the fluid being controlled has a low vapor pressure. Likewise, a lower Pressure-Recovery-Factor can be beneficial in situations where a greater pressure drop is desired.

For instance, in certain industrial processes, it might be necessary to reduce the pressure of a fluid quickly and significantly. This could be the case in systems where the fluid needs to be depressurized before entering a subsequent stage of the process.

A control valve with lower Pressure Recovery would allow for a larger pressure drop across the valve, as it has a lesser ability to recover pressure downstream. This means that the pressure downstream of the valve would be significantly lower than the pressure upstream of the valve, achieving the desired pressure drop.

Therefore, in applications where a greater pressure drop is required, a control valve with lower Pressure Recovery would be beneficial. This might include systems with high-pressure upstream conditions, or where the subsequent stages of the process require a lower pressure fluid.

Fluid Viscosity Cv Correction Factor

The viscosity (thickness) of the fluid affects the Cv sizing calculation of the valve. The thicker the fluid, the harder it is to move it through the valve. Therefore, thicker fluids need more capacity, and the calculated Cv will be adjusted higher, resulting in a possible larger valve. This adjustment is only needed when the fluid viscosity is above 40 centistokes. Most fluids are below this threshold, so this adjustment is rare, unless the fluid is very thick, like molasses, heavy bunker oil, or asphalt. The adjustment is done using a valve Reynolds number factor, which depends on the valve Fl, or the type of valve.

Temperature

Fluid vapor pressure is the pressure exerted by the vapor of a fluid in equilibrium with its liquid or solid phase. Fluid vapor pressure depends on the temperature of the fluid, as a higher temperature means more molecules have enough energy to escape the liquid or solid phase and enter the vapor phase. The relationship between fluid vapor pressure and temperature is often described by the Clausius-Clapeyron equation, which states that the natural logarithm of the vapor pressure is proportional to the inverse of the temperature.

Actuator Friction Factor

The actuator friction factor is a factor that affects the deadband of a control valve system. It is the ratio of the thrust and the friction in the actuator. The actuator friction factor can make the deadband performance worse, as it can cause a delay or an overshoot in the actuator movement. When the pressure in a pneumatic actuator increases, the actuator does not move until it overcomes the static friction. Then dynamic friction takes over, which is usually lower than static friction. This means that the actuator may respond slowly or move too far, as it passes the static friction point. This creates a complex relationship between the dynamic gain of the controller/positioner and the actuator response.

One might think that increasing the air pressure to the actuator would solve this problem, but it is not that simple. The higher air pressure does increase the thrust to friction ratio, but it also causes unstable oscillations due to overshoot and correction. Another possible solution is to use a larger actuator to increase the thrust to friction ratio. However, this also has some drawbacks. The larger actuator will need more air volume, which may result in longer dwell times before the actuator responds and have a similar effect on deadband before the valve responds. Moreover, larger air volumes also expand and contract more with temperature changes, and the increased force of the larger actuator can cause process instability with temperature changes.

These problems are common in control systems that have mismatched components. Therefore, it is important to use a tested and optimized control valve package that is designed for your application from a reliable brand like Bray.

Piping Geometry Factory

The piping geometry factor, represented by F_p , is a factor that adjusts the valve sizing calculation to account for the pressure and velocity changes caused by fittings that are directly connected to the valve, such as reducers, expanders, elbows, tees, and Y's. These fittings can disturb the flow and affect the valve capacity. The piping geometry factor is a dimensionless number that is usually provided by the valve manufacturers in their catalogues.

PIPING GEOMETRY FACTOR FORMULA

$$F_p = \frac{1}{\sqrt{1 + \frac{\Sigma K}{0.00214} \left(\frac{C_v}{D_v}\right)^2}}$$

WHERE:

F_p = piping geometry factor

D_v = nominal valve size

C_v = flow coefficient

ΣK = algebraic sum

If there are no fittings connected to the valve, the piping geometry factor is 1 however; F_p is also represented as an adjustment to the valve C_v calculation to compensate for the velocity and pressure changes caused by selecting smaller than line size valves and or correcting for reducers and expanders installed upstream and downstream of the control valve. It results in a higher required C_v for a given set of conditions.

Types of Control Valves

Rotary Control Valves

Rotary control valves usually have a ball or a disk that rotates through an angle (usually 90 degrees) to change the flow through the valve. The V-Control valve has a V-shaped slot or notch on the ball to create a specific flow control profile. The angle of the V affects the maximum and minimum flow rate or rangeability. The V-Control ball can replace a standard ball in many Bray ball valves, converting them into characterized control valves that are both economical and reliable.

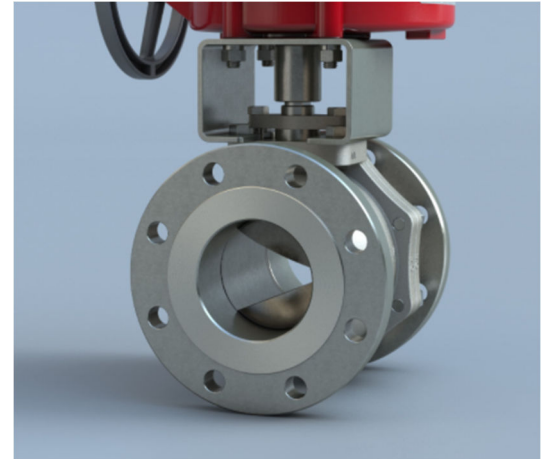

Bray V-Control F15 V-Port valve

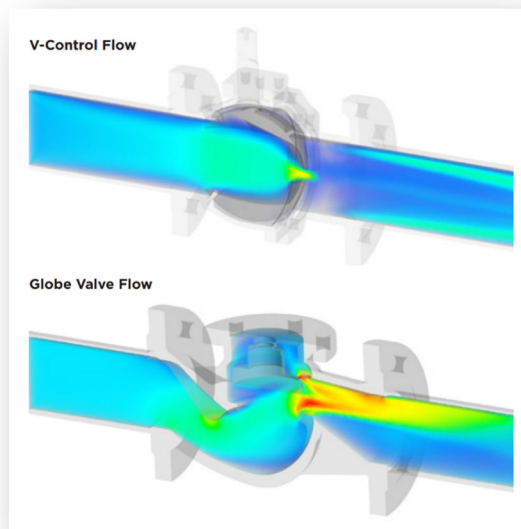

Ball vs. Globe performance.

Rotary control valves and globe valves are both integral components in fluid control systems, yet they exhibit distinct characteristics and are suited to different applications. Rotary control valves, known for their high rangeability and compact design, typically have a higher flow coefficient (C_v) than globe valves of the same size. They are favored for their smaller envelope dimensions, which save space and weight, and their simplicity results in lower cost. Rotary valves are particularly

effective in high-flow applications and offer superior flow control in both forward and reverse directions and applications requiring fast closing and zero leakage capabilities.

Globe valves, on the other hand, are recognized for their precise control of fluids. They feature a movable disk-type element with seat rings to block or permit flow. Globe valves are suited for applications requiring higher precision throttling characteristics and good rangeability. However, Globe valves are known to induce a substantial pressure drop across the valve due to their design and flow control functionality and higher cavitation. This is a trade-off for their precise flow control.

In summary, the choice of control valve depends on the specific requirements of the application, including factors such as flow capacity, control precision, pressure drop, available space, cost and maintenance requirements.

V-Control Ball Valve

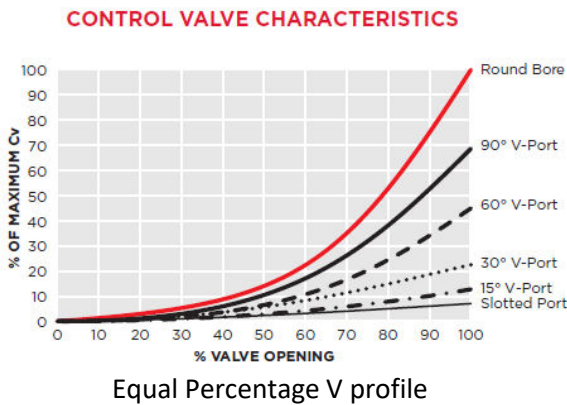

The V-Control ball valve, characterized by its V-shaped cut profile, exhibits an equal percentage flow characteristic that remains consistent, irrespective of the V-angle. This characteristic implies that the flow capacity escalates exponentially with uniform increments of travel, leading to proportional changes in the Cv (flow coefficient) of the control valve. The V-angle solely influences the valve’s rangeability, leaving the flow curve shape unaffected. For a given valve

size, a wider V-angle corresponds to reduced rangeability and coarser control. This highlights the intricate relationship between the V-angle, rangeability, and control precision in V-Control ball valves.

The geometry of the Characterized Ball can be tailored to any requisite shape to cater to the specific flow control needs of the customer’s application. The Custom V Port geometry has the flexibility to generate any necessary profile. Slit profiles, which yield a linear response, can be particularly efficacious for applications with small rangeability, especially in scenarios where the flow media is devoid of solids. This underlines the adaptability and precision of these control valve designs in meeting diverse application requirements. The customization characteristic of the V-Ball can create unique “characterized” flow control parameters, providing opportunities for control parameters where rapid response, stepped or other flow patterns are needed by the customer.



Examples of different geometry

Segmented Control Valve

A Segment Valve represents another variant of high-performance rotary control valves. It is composed of a partial ball sphere, equipped with a top and bottom shaft, akin to a trunnion ball valve. The segment is securely positioned like a trunnion valve, yet it features a singular floating seat. Segment valves boast a unique amalgamation of attributes. They exhibit a shearing action reminiscent of a knife gate valve, enabling them to slice through solids and slurries. Additionally, they possess a characterized control valve performance, facilitating precise and accurate flow regulation. Furthermore, they ensure an uninterrupted flow like a conventional ball valve, which can mitigate pressure drop and turbulence. This combination of features underscores the versatility and efficiency of Segment Valves in diverse applications.



Series 19 Segmented Valve.



Series S19 Segment

The Bray Series 19 segment valves are versatile, catering to a broad spectrum of process conditions and industries. They are available in a variety of trims and materials, designed to manage high solids content and abrasive or aggressive slurry. Like V-Control ball valves, Bray S19 control valves can be tailored with customized profiles to meet specific flow control requirements. Series 19 Segmented valves are adept at handling challenging media, including slurry or catalyst. Industries that deal with slurries, high-fiber media, or solids in the flow media, such as pulp and paper, mining, or wastewater treatment, can particularly benefit from segmented valves. These valves exhibit a self-cleaning action, designed to handle these challenging media, and prevent issues such as clogging, erosion, or cavitation.

This underscores their utility in maintaining efficient and uninterrupted operations in these industries.

Control Butterfly Valves

Although butterfly valves are not suitable for processes that require high precision control, they are a cost-effective alternative to other types of control valves in applications where coarse control is sufficient. The process conditions will determine whether a resilient seated or high-performance butterfly valve can be considered.



Series 39 Ceramic Lined



McCannalok Metal Seated

Because of their inherent design, butterfly valves may need larger actuator packages to hold the butterfly in place within the flow path during operation. This also affects process variability. The butterfly will be constantly resisting flow parameter fluctuations and typically have a lower control range compared to other rotary control valves such as ball and segment valves. Additionally, the flow rate is reduced due to the presence of the disc & stem in the flow path.

However, the butterfly valve can still be a good choice for low precision coarse control processes and offer significant cost savings compared to other types of control valves. Bray butterfly valves have good performance for coarse control applications. The Series 39 Ceramic Lined valve can handle abrasive media that needs throttling, while the McCannalok metal-seated high-performance Butterfly valves are ideal for high temperature applications. The standard McCannalok (double offset) butterfly valves are an excellent choice for applications that require zero leakage.



Mccannalok

Control Valve Positioners

A positioner is a device that controls the amount of air pressure applied to a valve actuator, so that the valve's position matches the desired set point from the control system. Positioners are usually needed when a valve must regulate the flow of a fluid. A positioner works by receiving feedback from the valve's position and adjusting the air pressure to the actuator accordingly. The positioner must be installed on or near the valve assembly. Positioners can be classified into three main types, based on the kind of control signal, the diagnostic capability, and the communication protocol.



Bray 6A Digital Positioner

There are four main types of valve positioners: pneumatic, electro-pneumatic, electro-hydraulic and Digital.

1. **Pneumatic Positioners:** Pneumatic valve positioners are analog and use air pressure for both the input signal and output control of the actuator. The input signal of the pneumatic positioner typically receives a pneumatic signal (3-15 or 6-30 psi) from a controller and in response supplies the valve actuator with air (usually 90 psi - 120 psi) as a proportional output to the pneumatic input signal from the controller. Pneumatic positioners are simple, reliable, and suitable for hazardous environments. There is no electrical signal involved in the pneumatic positioner.
2. **Electro-pneumatic valve positioners:** convert an electric signal (usually 4-20 mA, 0-5v VDC, 0-10 VDC) from a controller to a pneumatic signal for the valve actuator. They use a device called a pressure transducer to perform this conversion. They are more versatile and accurate than pneumatic positioners, but they require an electric power supply.

3. **Electro-Hydraulic Positioner:** An electro-hydraulic positioner is a device that uses electric power and hydraulic fluid to move a valve or other mechanical component. It consists of a motor, a pump, and a cylinder that are connected in a closed loop. The motor drives the pump, which generates hydraulic pressure and sends it to the hydraulic actuator. The actuator then pushes or pulls the valve stem or shaft, depending on the direction of the pressure. The position of the valve is monitored by a feedback sensor just like the electro-pneumatic valve positioner, by sending a signal back to the electro-hydraulic motor controller. The controller adjusts the speed and direction of the motor to maintain the desired position of the valve using the hydraulic fluid instead of air pressure but otherwise functions the same way as the electro-pneumatic system.

4. **Digital Positioners:** Digital valve positioners use a microprocessor to control the valve position via the actuator and monitor data. They receive a control input signal (usually HART, PROFIBUS, Foundation Fieldbus, Modbus, Canbus or analog 4-20 mA) and send a signal to the actuator control mechanism. They are very precise, efficient, and capable of performing advanced diagnostics and communication functions as well as other functions like a computer. Some of the significant advantages of digital positioners include:
 - a. **Auto-Tuning:** Digital positioners can automatically calibrate themselves in minutes, as opposed to the hours it can take for analog positioners.

 - b. **Diagnostic Information:** They provide real-time diagnostic information about the health and performance of your control valves²⁴. This allows for proactive maintenance and can help prevent unexpected downtime.

 - c. **Predictive Analytics:** Digital positioners can identify potential problems before they occur². This predictive capability can help to

improve the overall efficiency and reliability of the process control system.

- d. **Integration with Control Systems:** They can be integrated with other control systems, allowing all your data to be centralized in one place.
- e. **Process Gain Optimization:** Some digital positioners have the capability to change flow rate characteristics, optimizing the process gain.
- f. **Tight Shut-Off Function:** This function ensures compatibility between controllability and tight shut-off.
- g. **Energy Efficiency:** Since digital positioners have fewer mechanical moving parts, they last longer than their traditional pneumatic and analog counterparts⁴. Plus, they don't bleed any air while the valve is at rest, which reduces energy consumption.

These advanced functions make digital valve positioners invaluable in modern process control systems, contributing to higher productivity, decreased downtime, and better plant performance, improving the bottom line.

Whether pneumatic, electro-pneumatic, electro-hydraulic or electric, all valve positioners use PID loops to control the setpoints of pneumatic, hydraulic, or electric actuators. There are both digital and analog controllers, but digital ones are more common nowadays. The controller, position indicator, actuator, and valve must work together to regulate the control valve and control the process condition. All closed loop processing systems use a common communication protocol to exchange data between the control center and the positioner device.

Limit Switches

A valve limit switch is a device that is used to detect and indicate the open or closed position of a valve. It can be either a mechanical switch that is activated by the movement of the valve stem or shaft, or a proximity switch that senses the presence of a magnet or metal target on the valve. Valve limit switches are often used to provide feedback to a controller, monitor the status of a valve, or trigger an alarm or interlock in case of a valve failure

Bray 6A Digital Pneumatic Positioner

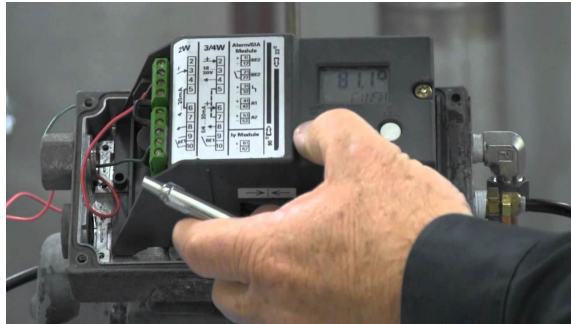

Bray 6A Controller setup

The Bray 6A Digital controller is a pneumatic positioner that can accept various input signals, including HART, Profibus, and 4-20mA signals. This makes it a suitable positioner for a wide variety of control valve applications. The 6A has a built-in position sensor and simple controls that enable quick and easy setup of the controller.

Bray 6P Pneumatic Positioner

The Bray Series 6P pneumatic positioner is a pneumatic-to-pneumatic positioner that controls quarter-turn valves. It is used to control valves such as butterfly and ball valves. The Series 6P provides fast, sensitive response characteristics. The Bray Series 6P positioner provides outstanding control for a wide range of quarter-turn valves. This design provides fast, sensitive response characteristics to meet the most demanding control objectives using a 3-15 psi pneumatic control signal.



Series 6P Pneumatic Positioner with High visibility Dome Position Indicator on top

A high visibility dome position indicator and 3 gauges are provided as standard. The Series 6P is available with options including position feedback limit switches, and a 4-20 mA position feedback transmitter.

Bray Servo NXT

Servo NXT is a Next-Generation modulating controller designed for the Series 70 Electric actuator. It has advanced features such as 1-touch automatic calibration, fine-tuned control over proportional and deadband functions, self-diagnostic functionality, and configurable open, closed, and last fail positions. It can operate with 120VAC, 220VAC, 24VAC 50/60Hz and 24VDC power, and it can provide precise modulating capability for continuous duty actuators.

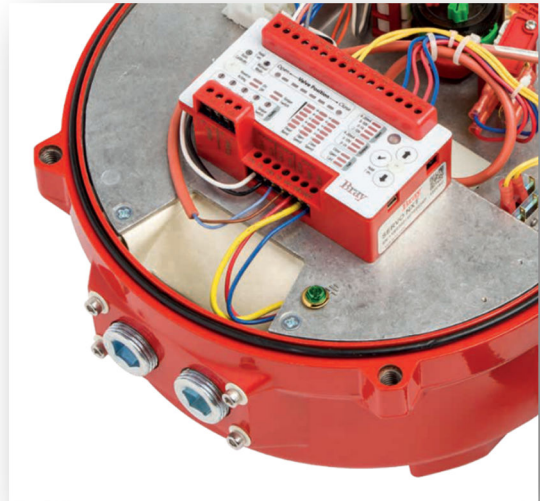

Control Valve Actuators

Actuation and controls are as important as the control valve itself for a control valve package. They affect the responsiveness, repeatability, reliability, accuracy, and dynamic control valve performance characteristics. These characteristics are achieved by extensive testing to create optimal control valve packages. Bray offers various types of actuators, including pneumatic, hydraulic, and electric actuators.

Scotch Yoke Actuators

The Scotch Yoke actuator is a type of actuator that converts linear motion into rotational motion. It has a piston and/or springs that are connected to a rotating yoke with a slot that engages the sliding blocks. This actuator has a specific torque curve that is high at the beginning and end of the stroke, and low in the middle. This matches the torque requirements of many valve applications. There are two types of yokes available: symmetrical and canted. The symmetrical yoke has a balanced torque curve that is suitable for applications where the torque requirements are similar at the break and end positions. The canted yoke has a shifted torque curve that can optimize the torque output for applications where the torque requirements are different at the break and end positions. The yoke type can be selected based on the valve torque requirement, so that it fits the needed torque values within the expected range. It is important to check that the actuator torque output is not higher than the maximum allowable torque of the valve shaft and the valve to actuator mounting interface.

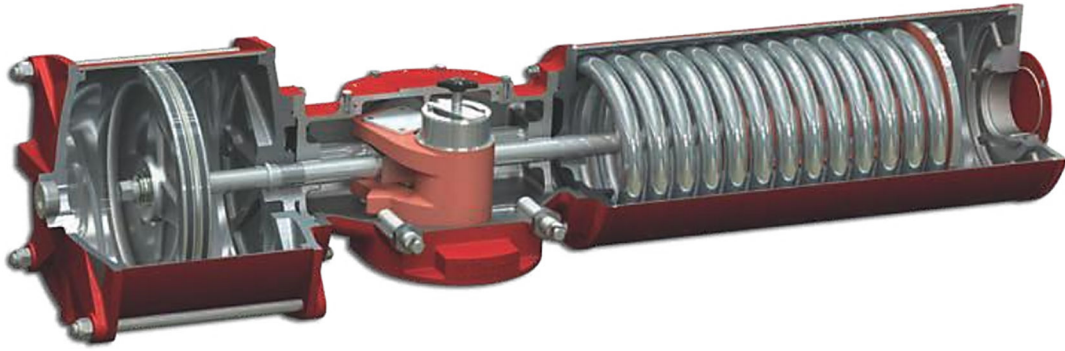

A Spring Return Scotch Yoke Actuator (Bray Series 98) Cross Sectional View



Symmetric Yoke where the Yoke slot is symmetric to the center axis.



Canted Yoke where the Yoke slot is inclined to the center axis.

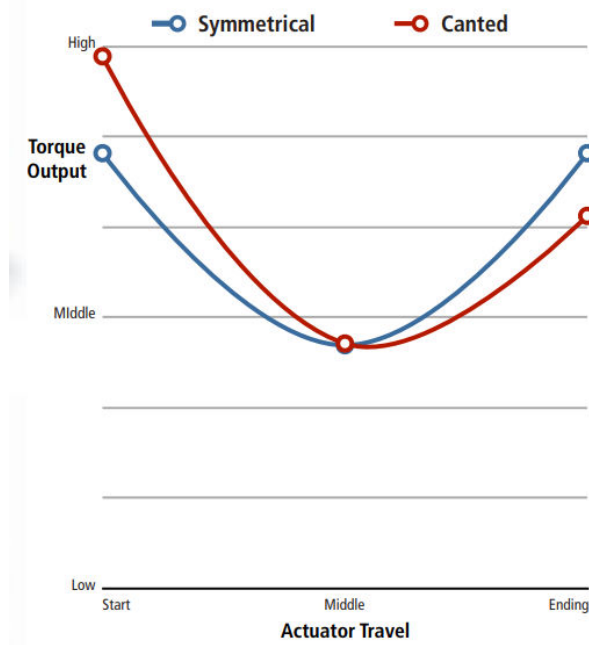

Rack & Pinion Actuators

Rack and Pinion actuators are ideal for control valve modulation, they can operate ball valves, butterfly valves, and other types of rotary valves. Bray Series 92 direct acting and Series 93 spring return pneumatic actuators are opposed-piston actuators that can provide double acting or spring return rotation of 90°, 135°, or 180°. Series S92 & S93 can also use other media such as hydraulic oil or water to actuate.



Figure 15: Bray Series 92 direct acting and Series 93 spring return pneumatic actuators are opposed-

Electric Actuators



Bray Series 70 Electric Actuator

Electric actuators have historically found acceptance in most areas of automation traditionally dominated by pneumatics except in modulating control applications. This is due to several factors. The gears in electric actuators have backlash, which creates deadband. The electric motors respond slowly because of the gear ratios needed to provide the torque. The motors also overheat due to constant use. Electric actuators also lack backup or failsafe control to move the valve in case of power failure, unlike spring return actuators.

Bray Series 70 electric actuators are designed for low power draw modulating service in smaller valves up to 18,000 in-lbs of torque. Series 70 also uses the Servo NXT kit, which provides precise modulating control and accepts industry standard inputs, such as 4-20mA, 0-10V, 0-5V, 2-10V. Servo NXT also provides motor stall protection, failure mode position for loss of signal, and other features for control valve modulating service.

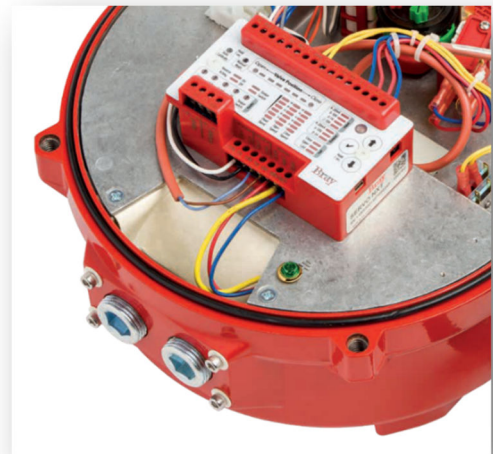

Bray's Servo Next module integrated with Servo Next for Control

Electro-Hydraulic Actuators

An electro-hydraulic actuator for control valves is a type of actuator that uses electric power as the main energy source and hydraulic fluid as the transmission medium to control the movement of a valve. An electro-hydraulic actuator consists of an electric motor, a hydraulic pump, a hydraulic actuator, and a control system. The electric motor drives the hydraulic pump, which generates pressurized fluid to operate the hydraulic actuator. The hydraulic actuator moves the valve spool or stem according to the signal from the control system. Electro-hydraulic actuators can provide precise and reliable control of valve position, velocity, pressure, and force, as well as high torque and force output. Electro-hydraulic actuators are suitable for applications that require high power, fast response, and safety features.

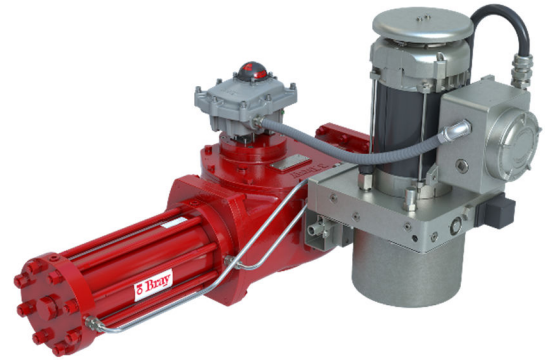

Bray S98H w/ Electro-Hydraulic Power Pack

Hydraulic control valve actuators are more precise than pneumatic control valve actuators because they use pressurized fluid to operate the valve, which is incompressible. This provided faster response, lower hysteresis and deadband. Hydraulics are also less susceptible to variations in pressure, temperature, and humidity, which can affect their performance and accuracy.



Bray's full line of S98 Actuators

Bray's Series 98 hydraulic actuator is part of our modular, fully configurable product designed primarily for hydraulic operation to a maximum pressure of 3000 psi (207 Bar) and for temperature ranges of -50°F (-46°C) to 212°F (+100°C).

Fugitive Emissions

Fugitive emissions are the unintended or accidental leaks of gases or vapors from industrial plants, such as control valves. These emissions can have negative impacts on the environment, health, and safety, as they can contribute to air pollution, greenhouse effect, and fire hazards. Therefore, there are various national and international standards and regulations that aim to reduce fugitive emissions from plants, such as the Clean Air Act in the United States and TA-Luft in Germany. These standards specify the testing methods, mediums, cycles, and leakage rates that the control valves must comply with, such as ISO 15848 and API 641. To meet these standards, Bray™ has developed low-emissions packings for its valve products, which provide enhanced sealing and long-life performance, where fugitive emissions standards demand it.

Leak Detection and Repair (LDAR) is a program that involves finding and fixing fugitive emissions from control valves and other components. LDAR requires the identification, monitoring, and recordkeeping of all components that are subject to fugitive emission regulations. LDAR also requires the repair of any leaking components within a specified time frame. LDAR can be done using different methods, such as hydrocarbon analyzers, optical imaging devices, or audio/visual/olfactory inspection. LDAR can help to improve the process performance, ensure safety and reliability, and reduce environmental impact. LDAR can also help to avoid penalties and fines for non-compliance with fugitive emission standards.

Summary

Control valves and process control valve packages consist of a valve, an actuator, a positioner, and sensors function together to control a process. It is essential to select the appropriate control valve package, not just the control valve itself, to ensure process stability and profitability. An improperly sized control valve can cause not only poor process control, but also safety issues. The following list outlines considerations when choosing your control valve solution:

1. **Materials of construction:** The process media should be compatible with the materials of construction of the valve components, including the seat materials and coatings, to avoid problems such as corrosion, erosion, and cavitation. The environmental conditions, such as NACE and corrosive agents, should also be considered for the exterior of the valve.
2. **Operating temperature and pressure:** The valve should be able to withstand the ambient and process temperature and pressure, and any variations in the atmospheric conditions.
3. **Control resolution:** The valve and control package should be able to achieve the desired process control parameters, such as responsiveness, deadband, hysteresis, resolution, and other performance factors.
4. **Inherent flow characteristics:** Different types of control valves have different flow characteristics (and curves), which affect the valve capacity and control performance.
5. **Rangeability:** The valve should have a range of operation that corresponds to the desired control range. It is a common practice to have the normal operating range between 50% and 70% of the opening angle. The maximum required flow should be achieved at around 90% of the travel. The minimum flows should occur at around 25% of the travel. Smaller openings can increase the risk of erosion, cavitation, and flashing.
6. **Cavitation prediction:** When modeling the valve in Bray Sizing software, pay attention to the warnings for cavitation predictions. Consult the factory or your sales representative for assistance.

-
7. **Valve sizing:** Do not oversize your control valve. A control valve that is too large will result in less process control resolution, because only a small portion of the travel range will be used. Oversized actuators will also be more prone to hunting.
 8. **Precision instruments:** Control valves used in process control are not commodity valves, they are sophisticated instruments.
 9. **Installed flow characteristics:** Do not always match the theoretical predictions. For new applications, it is important to take this into account to ensure that the control valve package can address the real-world dynamic characteristics and optimize the process.
 10. **Control valve package:** The performance of the individual parts of a control valve package does not equal the performance of an optimized control valve package that has been extensively tested, simulated, and proven in real-world flow conditions.
 11. **Rotary control valves:** Can provide exceptional process control performance when properly configured and sized for an application. The rangeability can vary from 100:1 to 2400:1. Different slot profiles can characterize the valve for a wide variety of control applications, including quick opening by reversing the V-Control opening direction. More complex port geometry can provide unique customized flow characteristics. Rotary control valves, such as V-Control and Segmented control valves, offer economical solutions compared to globe valves.
 12. **Consult Bray™:** Process optimization depends on optimizing the entire control valve package. We are here to help. Do not forget that the in-process conditions can affect the process stability too. Provide as much information as possible when consulting Bray for your application.

References

1. ISA 75.05.01 2005: Control Valve Terminology
2. ANSI/ISA-75.01-01: Flow equations for sizing Control Valves
3. ANSI/ISA-75.02.01: Control Valve Capacity Test Procedure
4. ASI/FCI 70.2.2021: Standard for Control Valve Seat Leakage Testing
5. The PID Control Algorithm, 2nd Edition, John A. Shaw
6. Quarter-Turn Solutions for Fugitive Emissions:
https://www.bray.com/docs/default-source/manuals-guides/application-guides/knowledge-center/1069_fugitive-emissions_6_15_2020-min.pdf
7. Control Valve Sizing Theory, Cavitation, Flashing:
<https://www.bray.com/docs/default-source/webinar-presentations/control-valve-sizing-theory-cavitation-flashing.pdf>

Glossary

Actuator: An actuator is a mechanical, hydraulic, electric, or pneumatic device that positions the valve trim to control the monitored process. It responds to signals from controllers and adjusts the valve accordingly 123.

Actuator Friction Factor: The actuator friction factor refers to the resistance encountered by the actuator during movement. It affects the responsiveness and accuracy of the valve control.

ANSI (American National Standards Institute): ANSI is a standard development organization responsible for coordinating U.S. standards writing groups and collaborating with other national standards organizations 1.

API (American Petroleum Institute): API develops standards for the oil and gas industry, including guidelines for control valves and related equipment.

API 641: API 641 specifies requirements for fugitive emissions testing of quarter-turn valves, including control ball valves and butterfly valves.

ASME (American Society of Mechanical Engineers): ASME sets standards for various engineering disciplines, including those related to control valves.

ASTM (American Society for Testing and Materials): ASTM develops standards for materials used in control valves and other industrial applications.

Ball Valve: A ball valve uses a spherical closure element (the ball) to regulate fluid flow. It provides tight shut-off and is commonly used in various applications.

Bernoulli's Principle: Bernoulli's principle relates the pressure and velocity of a fluid in a pipe. It states that as the velocity increases, the pressure decreases, and vice versa.

Butterfly Valve: A butterfly valve uses a disc-shaped closure element (the butterfly) to control flow. It is lightweight and suitable for large-diameter pipelines.

CANBUS: Canbus (Controller Area Network) is a communication protocol used in industrial automation systems.

Cavitation: Cavitation occurs when rapid pressure changes cause vapor bubbles to form and collapse within the fluid, potentially damaging the valve.

CFD (Computational Fluid Dynamics): CFD simulates fluid flow and heat transfer using numerical methods. It aids in valve design and performance analysis.

Clean Air Act: The Clean Air Act is a U.S. federal law regulating air quality and emissions.

CRN (Canadian Registration Number): The CRN is a registration number for pressure equipment in Canada.

Choke Plates: Choke plates restrict flow to control pressure or flow rate.

Clausius-Clapeyron Equation: The Clausius-Clapeyron equation relates temperature, pressure, and vaporization properties of a fluid.

Control Ball Valve: A control ball valve regulates flow using a ball-shaped closure element.

Control Valve: A control valve varies flow by adjusting the size of the flow passage based on signals from controllers.

Control Loop: A control loop includes the controller, actuator, and sensor to maintain a desired process variable.

Controller: A controller is a device that measures a controlled variable (such as pressure, temperature, or flow rate), compares it with a predetermined setpoint, and generates an output signal to adjust the control valve accordingly. It plays a crucial role in maintaining process stability and achieving desired process conditions.

Diverging Nozzles: Diverging nozzles are components in fluid systems that gradually expand the flow passage. They are commonly used in steam turbines, rocket engines, and supersonic nozzles. The expansion allows the fluid to gain velocity while converting internal energy into kinetic energy.

Deadband: Deadband refers to a range of input values around the setpoint where no control action occurs. In control valves, deadband represents the zone where the valve remains stationary even if the process variable deviates slightly from the desired value. Minimizing deadband improves control accuracy.

Derivative:

The derivative term in a control algorithm provides a control action based on the rate of change of the process variable. It helps dampen oscillations and stabilize the system. Derivative control responds to rapid changes in the process variable 5.

Distributed Control Systems (DCS): A Distributed Control System (DCS) is a networked system that integrates various control elements (such as control valves, sensors, and actuators) to manage and optimize industrial processes. DCS allows centralized monitoring and decentralized control.

Electric Actuator: An electric actuator converts electrical energy into mechanical motion to position the valve. It is commonly used in control valves for precise and automated control.

Electro-Hydraulic: Electro-hydraulic systems combine electrical and hydraulic components to control valve actuators. They provide flexibility and responsiveness in various applications.

Electro-Pneumatic: Electro-pneumatic systems use electrical signals to control pneumatic actuators. These systems are prevalent in industrial automation and process control.

End Connections: End connections refer to the fittings or flanges at the inlet and outlet of a control valve. They allow the valve to be connected to the process piping.

EPC (Engineering, Procurement, and Construction): EPC refers to the integrated process of designing, procuring materials, and constructing industrial facilities. Control valves play a vital role in EPC projects.

Equal Percentage: Equal percentage is a flow characteristic used in control valves. It means that equal increments of valve opening result in equal percentage changes in flow rate. This characteristic provides better control over a wide range of flow rates.

Erosion: Erosion occurs when high-velocity fluid flow causes gradual material removal from valve components (such as the valve seat or trim). Proper material selection and design can mitigate erosion effects.

Fail Position: Fail position refers to the predetermined position of a control valve when the actuator or control signal fails. Common fail positions include fail open (valve opens) and fail closed (valve closes).

Feedback: Feedback in control systems involves measuring the actual process variable and comparing it to the desired setpoint. Feedback signals help adjust the control action to maintain stability.

Flashing: Flashing occurs when a liquid abruptly changes to vapor due to pressure drop across the valve. It can lead to cavitation and affect valve performance.

Flow Capacity: Flow capacity (often denoted as C_v) represents the maximum flow rate a control valve can handle at a specified pressure drop. It influences valve sizing and selection.

Final Control Element: The final control element is the component (usually a control valve) that directly adjusts the process fluid flow to achieve the desired process conditions.

Flow Recovery Factor: The flow recovery factor accounts for the pressure recovery downstream of a control valve. It affects the overall system efficiency.

Foundation Fieldbus: Foundation Fieldbus is a digital communication protocol used in process automation. It enables communication between field devices and control systems.

Fugitive Emissions: Fugitive emissions refer to unintended leaks of gases or vapors from process equipment, including control valves. These emissions can contribute to environmental pollution and safety hazards. Efforts to minimize fugitive emissions involve proper valve design, packing, and maintenance.

Globe Valve: A globe valve is a linear motion valve with a spherical-shaped body. It provides precise flow control by raising or lowering a disc (plug) into the flow path. Globe valves are commonly used for throttling applications.

Gain: Gain represents the sensitivity of a control system. It quantifies how much the output (e.g., valve position) changes in response to a change in the input (e.g., controller signal). High gain results in rapid response but may lead to instability.

HART (Highway Addressable Remote Transducer): HART is a communication protocol used in smart field devices, including control valves. It allows digital communication over analog signal lines, enabling additional diagnostic and configuration capabilities.

High Recovery Valve: A High Recovery Valve is a valve design that dissipates relatively little flow Stream Energy due to streamlined internal contours and minimal flow turbulence. As a result, the pressure downstream of the valve vena contracta recovers to a high percentage of its inlet value. This design is intended to minimize pressure loss by streamlining the flow passage. Therefore, it's particularly beneficial in applications where maintaining pressure is crucial.

Hunting: Hunting refers to oscillations or instability in a control loop. It occurs when the control valve rapidly alternates between opening and closing due to excessive gain or improper tuning.

Hysteresis: Hysteresis is the phenomenon where the valve's response depends on its previous state. In control valves, it refers to the difference in valve position for the same input signal during opening and closing cycles.

Induced Pressure Gradient: The induced pressure gradient occurs across a control valve due to fluid acceleration or deceleration. It affects flow behavior and can lead to cavitation or erosion.

Integral: The integral term in a control algorithm provides control action based on the accumulated error (difference between setpoint and process variable) over time. It helps eliminate steady-state errors.

ISA (International Society of Automation): ISA develops standards and practices related to automation and control systems. ISA standards cover various aspects of control valves and instrumentation.

ISO 15848: ISO 15848 specifies testing procedures for evaluating the fugitive emission performance of valve stem seals. It ensures compliance with environmental regulations.

Leakage Rate: Leakage rate quantifies the amount of fluid that escapes through a closed valve. It is crucial to assess valve performance and prevent fugitive emissions.

Leak Detection and Repair (LDAR): LDAR programs aim to identify and address fugitive emissions from valves and other equipment. Regular inspections and maintenance help reduce leaks.

Limit Switch: A limit switch is an electrical device attached to a valve actuator. It signals when the valve reaches a specific position (e.g., fully open, or fully closed).

Line Size: Line size refers to the nominal diameter of the pipeline where the control valve is installed. Proper sizing ensures efficient flow control.

Linear Control Valve: A linear control valve provides a direct relationship between valve position and flow rate. It is ideal for applications where flow changes linearly with the valve opening.

Low Recovery Valve: A low recovery valve is designed for applications with minimal pressure drop. It prevents cavitation and erosion while maintaining stable flow control.

Media: Media refers to the fluid (liquid, gas, or vapor) that flows through the control valve. Proper material selection considers the properties of the media.

Modbus: Modbus is a communication protocol widely used in industrial automation. It allows devices (such as control valves) to exchange data with controllers or other devices over a serial connection. Modbus facilitates real-time monitoring and control of field instruments.

Modified Parabolic: The term modified parabolic typically refers to the flow characteristic of a control valve. It describes how the valve's flow capacity changes with the valve opening. A modified parabolic characteristic provides better control over a wide range of flow rates.

Noise: Noise in control valves refers to unwanted sound generated during fluid flow. It can result from turbulence, cavitation, or other factors. Proper valve design and sizing help minimize noise.

Normally Closed: A valve is considered normally closed when it remains closed in the absence of any control signal. It opens only when an external signal (such as from a controller) is applied.

Normally Open: Conversely, a valve is normally open when it remains open without any control signal. It closes only when an external signal is received.

OSHA (Occupational Safety and Health Administration): OSHA is a U.S. federal agency responsible for enforcing workplace safety regulations. It sets guidelines to ensure safe working conditions, including those related to control valves and other equipment.

Overshoot: Overshoot occurs when a control valve temporarily exceeds the desired setpoint during its response to a change in input. It can lead to instability in the control loop.

PED (Pressure Equipment Directive): The PED is a European Union directive that sets safety requirements for pressure equipment, including control valves. Compliance ensures safe operation and design.

Piping Geometry Factor: The piping geometry factor accounts for the effect of pipe bends, fittings, and other geometry on the flow behavior near the control valve. It influences valve sizing and performance.

PID Loop: A PID loop (Proportional-Integral-Derivative loop) is a control algorithm that combines proportional, integral, and derivative actions to regulate a process variable. Control valves play a crucial role in PID loops.

Pneumatic Actuator: A pneumatic actuator uses compressed air to position the valve. It is commonly used in control valves for fast response and reliability.

Positioner: A positioner is an accessory attached to a control valve actuator. It ensures precise positioning of the valve based on the control signal from the controller.

Precision: Precision in control valves refers to the ability to achieve accurate and repeatable control. Precise valves minimize deviations from the desired setpoint.

Pressure Class: Pressure class specifies the maximum pressure a valve can handle safely. It helps users select valves suitable for their specific pressure requirements.

Pressure Recovery Factor: The pressure recovery factor accounts for the pressure increase downstream of a control valve. It affects the overall system efficiency and energy losses.

PROFIBUS: PROFIBUS is a fieldbus communication protocol used in industrial automation. It enables data exchange between devices in a network.

Process: In the context of control valves, process refers to the overall system or industrial operation where the valve plays a role. It includes fluid handling, temperature control, pressure regulation, and other relevant factors.

Process Data: Process data includes information related to the operating conditions, fluid properties, and performance requirements within a control system. Control valves rely on accurate process data for optimal operation.

Process Variability: Process variability refers to fluctuations or changes in the process conditions (such as flow rate, pressure, or temperature). Control valves help manage and stabilize process variability.

Programmable Logic Controllers (PLCs): PLCs are digital computers used for automation and control. They execute control algorithms, communicate with field devices (including control valves), and manage industrial processes.

Proportional: A proportional control valve adjusts the flow rate in proportion to the input signal it receives. It modulates fluid flow continuously based on the control system's requirements, maintaining a linear relationship between the input signal and the valve position.

Quick Opening: A quick-opening valve rapidly opens to allow maximum flow when the control signal changes, commonly used for applications where immediate response is crucial, such as emergency shutdowns or safety systems.

Rack & Pinion Actuator: This actuator mechanism converts rotary motion (from a pinion gear) into linear motion (along a rack). It is often employed in quarter-turn valves, providing reliable and compact actuation.

Reliability: Refers to the consistent performance and durability of a control valve over time. Reliable valves minimize downtime, reduce maintenance costs, and ensure safe operation.

Rangeability: Also known as turndown ratio, rangeability represents the ability of a valve to handle a wide range of flow rates while maintaining accurate control. Higher rangeability allows precise adjustments across varying flow conditions.

Resolution: The smallest change in the control signal that the valve can detect and respond to. A valve with high resolution can make fine adjustments, enhancing control accuracy.

Repeatability: Describes how consistently a valve returns to the same position for the same input signal. A repeatable valve ensures consistent process control during repetitive operations.

Rotary Control Valve: A type of control valve with a rotary motion (such as a butterfly or ball valve). It modulates flow by rotating a disc or ball within the valve body.

Scotch Yoke Actuator: An actuator design that converts linear motion into rotary motion. It is commonly used in reciprocating valves, providing high torque output.

Setpoints: The desired process conditions (e.g., pressure, temperature, or flow rate) that the control system aims to achieve. Setpoints guide the valve's operation.

Segmented Control Valve: A valve with multiple segments or plugs that can be independently controlled. It allows fine-tuning of flow profiles and is useful in complex processes.

Service Life: The expected operational lifespan of a valve before maintenance or replacement is necessary. Factors affecting service life include material quality, operating conditions, and maintenance practices.

Servo: Refers to a feedback-controlled system that continuously adjusts the valve position based on real-time process measurements. Servo valves provide precise control.

Sigma: In control valve context, "sigma" likely refers to the standard deviation or variability of valve performance. Lower sigma values indicate more consistent behavior.

Sizing: The process of selecting an appropriately sized control valve based on flow requirements, pressure drop, and other factors. Proper sizing ensures optimal performance.

Simulation: The use of mathematical models or software to predict valve behavior under different conditions. Simulation aids in design, troubleshooting, and optimization.

Software: Control valve software includes tools for sizing, selection, and configuration. It assists engineers in choosing the right valve for a specific application.

Square Root: Often used in control algorithms, the square root function helps linearize flow signals or pressure drops. It converts nonlinear relationships into linear ones.

TA-Luft: Refers to the German Technical Instructions on Air Quality Control. It outlines emission control requirements, including valve sealing standards, to prevent fugitive emissions.

Temperature: Temperature refers to the degree of hotness or coldness of a substance. In control valve applications, temperature affects fluid properties (such as viscosity) and can impact valve performance.

Trim: The trim of a control valve consists of internal components (such as the plug, seat, and stem) that directly interact with the fluid flow. Proper trim selection ensures efficient control and minimizes wear.

Tortuous Path: A tortuous path refers to a complex, winding flow passage within a valve or piping system. It can reduce pressure drop, dampen vibrations, and promote better mixing or heat exchange.

Valve: A valve is a mechanical device that regulates fluid flow by opening, closing, or partially obstructing the flow passage. Valves play a crucial role in controlling process variables.

Valve Controller: The valve controller receives signals (such as from a control system) and adjusts the valve position accordingly. It ensures precise control based on setpoints and feedback.

Vapor Point: The vapor point is the temperature at which a liquid transition into its vapor (gas) phase. It is essential to prevent cavitation in control valves.

Vena Contracta: The vena contracta is the point downstream of an orifice where fluid velocity is highest, and pressure is lowest. It occurs just after the smallest flow area, impacting valve performance.

VAC (Volts Alternating Current): VAC represents the voltage of an alternating current (AC) power supply. It may be used for actuating solenoid valves or other electrical components.

VDC (Volts Direct Current): VDC refers to the voltage of a direct current (DC) power supply. It is commonly used for powering electronic components in valve controllers.

Vibration: Vibration in control valves can result from fluid flow, pressure fluctuations, or mechanical interactions. Excessive vibration can affect valve stability and reliability.

Viscosity: Viscosity measures a fluid's resistance to flow. High-viscosity fluids (like thick oils) require different valve designs and trim materials than low-viscosity fluids (like water).

**“Trust Bray’s team of
Control Valve Experts
for your Control Valve needs”**

SINCE 1986, BRAY HAS PROVIDED FLOW CONTROL SOLUTIONS FOR A VARIETY OF INDUSTRIES AROUND THE WORLD.

VISIT [BRAY.COM](https://www.bray.com) TO LEARN MORE ABOUT BRAY PRODUCTS AND LOCATIONS NEAR YOU.

HEADQUARTERS

Bray International, Inc.

13333 Westland East Blvd.

Houston, Texas 77041

Tel: +1.281.894.5454

All statements, technical information, and recommendations in this bulletin are for general use only. Consult Bray representatives or factory for the specific requirements and material selection for your intended application. The right to change or modify product design or product without prior notice is reserved. Patents issued and applied for worldwide.



THE HIGH PERFORMANCE COMPANY